

REMOTE CONTROL USER GUIDE

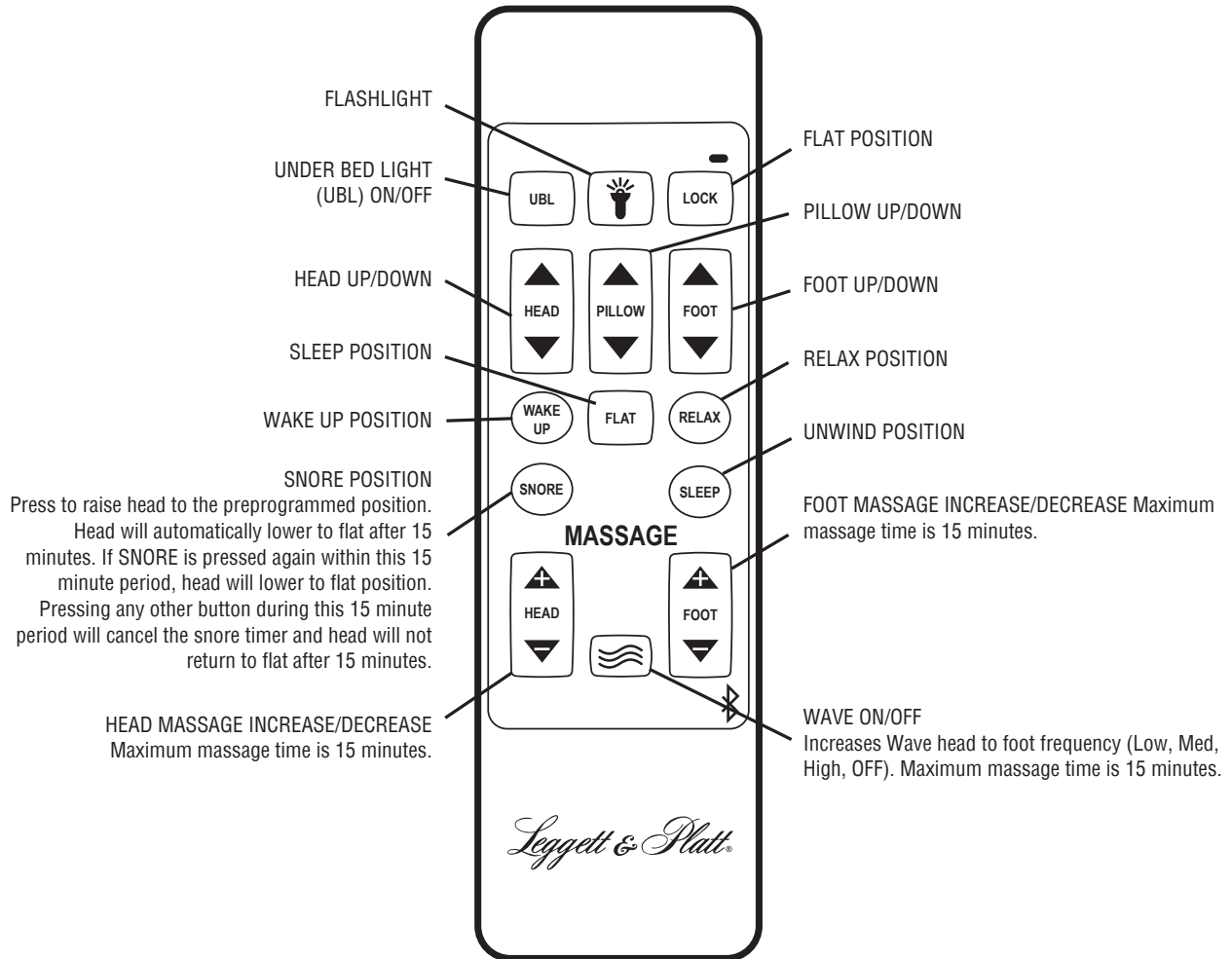

CUSTOMER SERVICE toll free: (800) 888-3078

REMOTE CONTROL FUNCTION



UNWIND, SLEEP, WAKE UP, AND RELAX BUTTONS:

PRESS TO RAISE BASE TO THE PREPROGRAMMED POSITION. PREPROGRAMMED POSITIONS ARE REPROGRAMMABLE THROUGH THE LP COMFORT CONNECT MOBILE APP ONLY.



NOTE

IF REMOTE HAS BEEN PREVIOUSLY PAIRED TO ANOTHER BASE, PRESS AND HOLD THE HEAD UP AND FOOT DOWN BUTTONS UNTIL THE REMOTE BACKLIGHT FLASHES TO UNPAIR IT, THEN FOLLOW THE BELOW INSTRUCTIONS.

REMOTE CONTROL PROGRAMMING - 1 REMOTE TO OPERATE 1 BASE

- 1 Plug base into power outlet. You now have 2 minutes to complete the programming procedure.

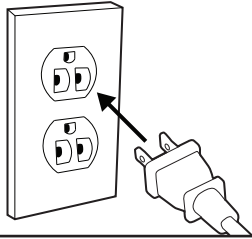

NOTE
AN ELECTRICAL SURGE PROTECTION DEVICE IS RECOMMENDED (NOT INCLUDED).

- 2 Remove battery compartment door on back of remote then install 3 AAA batteries.

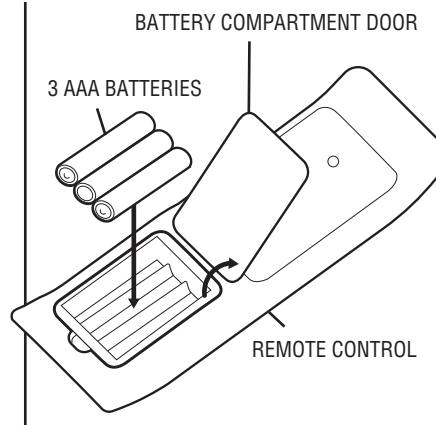

- 4 Operate the remote control to verify the base functions correctly.

- 3 Simultaneously press and hold both the HEAD DOWN and FOOT UP buttons on the remote control. Hold until the remote backlight starts flashing, then release all buttons.

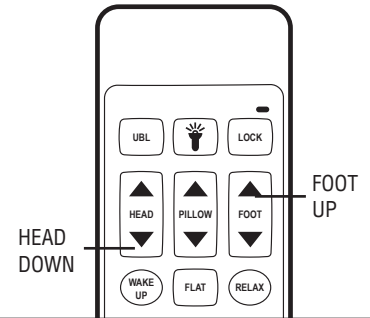

NOTE
REMOTE BACKLIGHT WILL FLASH QUICKLY FOR 3 SECONDS WHEN PAIRED TO BASE, THEN BACKLIGHT WILL TURN OFF.

REMOTE CONTROL PROGRAMMING - 1 OR 2 REMOTES TO OPERATE 2 BASES

- 1 Plug both bases into power outlet. Operate each base to verify the base functions properly.

Lower both bases to the flat position.



NOTE
IF BASES DO NOT RESPOND, REVERT BACK TO 1-TO-1 PROGRAMMING.

- 2 UNPLUG both bases. Place both bases on their sides close to each other.



CAUTION

DUE TO RISK OF INJURY, TWO ADULTS ARE REQUIRED TO HANDLE AND MOVE ADJUSTABLE BASE.

- 3 Plug one end of the sync cable into the C1 port (on the control box) of base 1. Plug the other end of the sync cable into the C1 port (on the control box) of base 2.

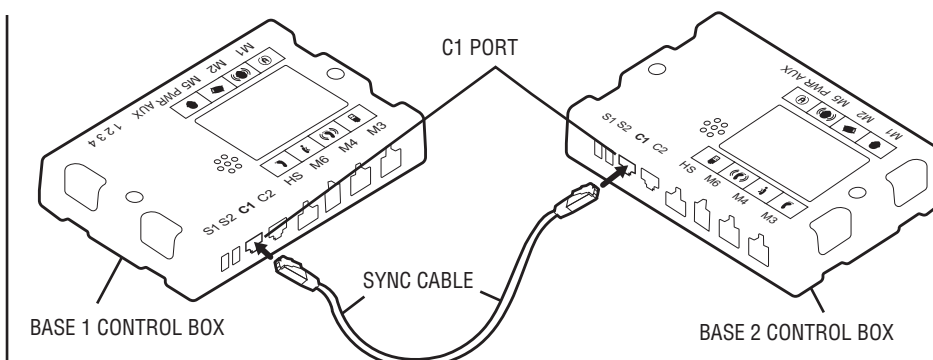

- 4 Turn both bases over onto their legs.



CAUTION

MAKE SURE SYNC CABLE IS NOT CAUGHT IN BASE OR PINCH POINTS.

- 6 Operate the remote control(s) to verify both bases function correctly. If using only one remote control to operate both bases, store the second remote for use as a spare.



NOTE
TO REVERT BACK TO 1-TO-1 PROGRAMMING, REMOVE SYNC CABLE FROM CONTROL BOXES.

- 5 Plug both bases back into power outlet.

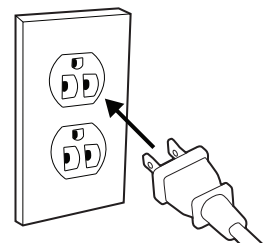

NOTE
AN ELECTRICAL SURGE PROTECTION DEVICE IS RECOMMENDED (NOT INCLUDED).

POWER DOWN OPERATION

Your adjustable base, depending on model purchased, may have the following feature. Use this procedure to lower the base to flat during a power outage. Do NOT put batteries in power down device until necessary for use.

- 1 Unplug power brick from PWR port on control box.

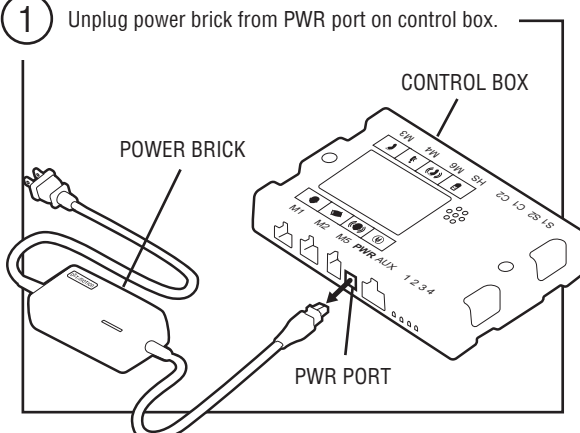
- 2 Insert (2) 9-volt alkaline batteries into the power down device.

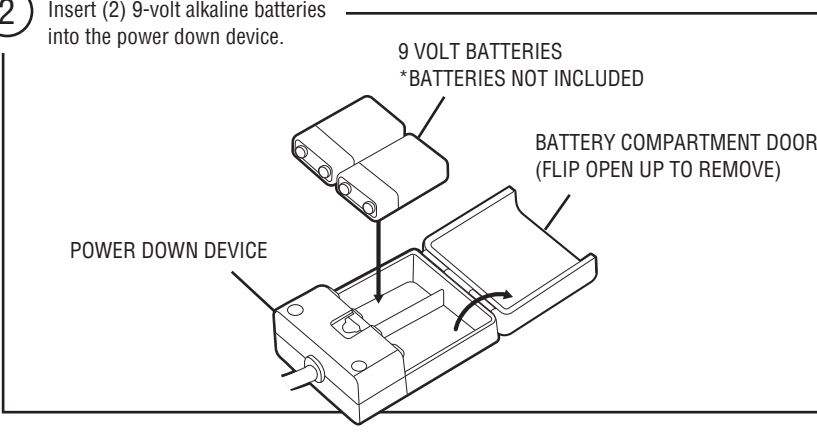
- 3 Plug power down device into PWR port on control box.

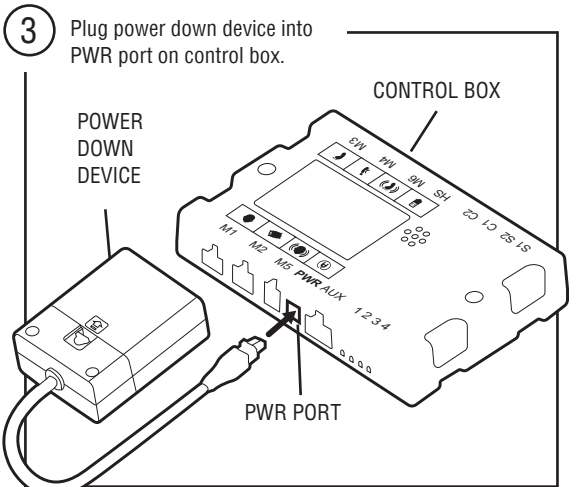
- 4 Press the FLAT BUTTON on the remote control to adjust the base to the level position.

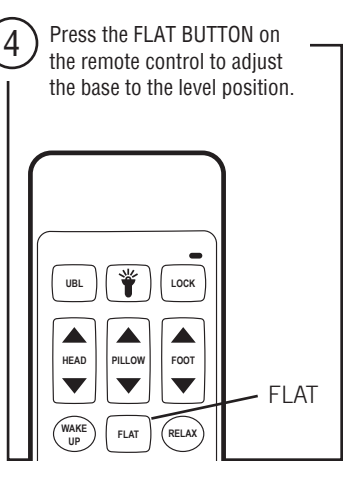
- 5 Remove batteries from power brick and discard. When power is restored from outage, base is ready to resume normal operation.

 **NOTE**
BATTERIES (NOT INCLUDED) ARE GOOD FOR ONLY ONE USE.

TROUBLESHOOTING

If the adjustable base fails to operate, investigate the symptoms and possible solutions provided in the chart below:

If the adjustable base fails to operate, investigate the symptoms and possible solutions provided in the chart below:

SYMPTOM	SOLUTION
No features of the base will activate.	<ul style="list-style-type: none"> • Program the remote control (see Remote Control Programming section of this manual for programming procedures). • Unplug power cord, wait 30 seconds and plug in to reset electronic components. • Electrical circuit breaker may be tripped. Check electrical service breaker box to verify. • Defective surge protection device or electrical outlet. Test outlet by plugging in another working appliance. • If the base was operated over the rated duty cycle, thermal switch opens. Wait 30 minutes before trying to operate the base. Once the base resumes normal operation, do not exceed the duty cycle.
Remote control backlight does not illuminate.	<ul style="list-style-type: none"> • Replace batteries in remote control.
Head or foot section will elevate, but will not return to the horizontal (flat) position.	<ul style="list-style-type: none"> • Base mechanism may be obstructed. Elevate base and check for obstruction. Remove obstruction. • Head section may be too close to the wall.
Excessive motor noise.	<ul style="list-style-type: none"> • If base is located on hard surface flooring, place carpet pieces or rubber caster cups under each leg or caster of the base. • Elevate the head or foot section a short distance (with the remote control) to realign the lift/lower mechanisms with the base support platform. • Verify that base is not positioned against a wall, nightstand, or other object that may cause vibration or noise. • If base is installed over a base frame, verify motors are not causing base frame (or base frame components) to vibrate.
Remote control paired to wrong bases.	<ul style="list-style-type: none"> • De-sync your remote control (see De-Syncing Your Remote section of this manual for de-syncing procedure).

ADVISORY

IMPORTANT INFORMATION

READ THE FOLLOWING INFORMATION CAREFULLY BEFORE USING THIS PRODUCT



WARNING

FOR OPTIMUM ADJUSTABLE BASE OPERATION, USE A GROUNDED, ELECTRICAL SURGE PROTECTION DEVICE (NOT INCLUDED). FAILURE TO USE A SURGE PROTECTION DEVICE COULD COMPROMISE SAFETY OR CAUSE PRODUCT MALFUNCTION.

ELECTRICAL RATING

Input: 100-240VAC, 50/60Hz, 2.5A. Output: 29VDC, 2A.

ELECTRICAL GROUNDING

This product is equipped with a polarized or grounded electrical power cord. The power cord will only fit into a grounded, electrical surge protection device (not included) or a grounded electrical outlet.

WARRANTY WARNING

Do not open any control boxes, motors or remote control devices (with the exception of the remote control and power down box battery compartments). The product warranty will be void if these components are tampered with. Do not attempt to alter component wiring or adjust or modify the structure of the product in any way or the warranty will be void. Any repair or replacement of base parts must be performed by authorized personnel.

LUBRICATION

This product is designed to be maintenance free. The lift motors are permanently lubricated and sealed—no additional lubrication is required. Do not apply lubricant to lift motor lead screws or any nylon nuts or the base may inadvertently creep downward from the elevated position.

LOCATION ENVIRONMENT

The level of sound experienced during operation is directly related to the location environment.

SERVICE REQUIREMENTS

Service technicians are not responsible for moving furniture, removing headboards and footboards or any items required to perform maintenance on the base. In the event the technician is unable to perform service due to lack of accessibility, the service call will be billed to the purchaser and the service will have to be rescheduled.

PRODUCT RATINGS

The base lift motors are not designed for continuous use. Reliable operation and full life expectancy will be realized as long as the lift motor operation does not exceed two (2) minutes over a twenty (20) minute period, or approximately 10% duty cycle. Note: Massage equipped bases are not designed for continuous, extended massage operation. Massage systems are rated for a maximum of 2 hours of use within any 6 hour period. Any attempt to circumvent or exceed product ratings will shorten the life expectancy of the product and may void the warranty.

The recommended maximum weight (including mattress) is 850 lb (385 kg) distributed evenly across the base. This product is not designed to support or lift this amount in the head or foot sections alone. Note: Exceeding the recommended weight restrictions could damage the base and void the warranty.

For best performance, consumers should enter and exit the adjustable base with the base in the flat (horizontal) position. Avoid placing entire weight on head or foot section of the base, including when in the raised position. **DO NOT STAND ON BASE AT ANY TIME.**

UL (Underwriters Laboratories) recognized components.

Adjustable base is tested to UL (Underwriters Laboratories) standards.

CFR 1633 approved for use with most mattresses.

SMALL CHILDREN / PETS WARNING

After the base is unboxed, immediately dispose of packaging material as it can smother small children and pets. To avoid injury, children or pets should not be allowed to play under or on the base. Children should not operate this base without adult supervision.

HOSPITAL USE DISCLAIMER

This base is designed for in-home use only. It is not approved for hospital use and does not comply with hospital standards. Do not use this base with tent type oxygen therapy equipment, or use near explosive gases. Manufacturer makes no representation or warranty that the adjustable base constitutes a medical device or is suitable for medical or therapeutic use.

PACEMAKER WARNING

This product produces a vibrating sensation. It is possible that individuals with heart-assist pacemakers may experience a sensation similar to exercise. Consult physician for complete information.

MASSAGE OPERATION

The massage feature will emit a minimal tone during operation. This is normal. When the massage level is increased, motor resonance will intensify accordingly.

LIFTING/LOWERING MECHANISMS

The lift/lower feature will emit a minimal humming sound during operation. This is normal. If excessive noise or vibration is experienced, reverse the movement action (up or down) of the base with the remote control. This should realign the base's activating mechanisms to the proper operational position.

FCC COMPLIANCE

The equipment has been tested and found to comply with the limits for a Class B digital device, pursuant to Part 15 of the FCC Rules. These limits are designed to provide reasonable protection against harmful interference when the equipment is operated in a residential environment. This equipment generates, uses, and can radiate radio frequency energy and, if not installed and used in accordance with the instruction manual, may cause harmful interference to radio communications. However, there is no guarantee that interference will not occur in a particular installation. If this equipment does cause harmful interference to radio or television reception, which can be determined by turning the equipment off and on, the user is encouraged to try to correct the interference by one or more of the following measures:

- Reorient or relocate the receiving antenna.
- Increase the separation between the equipment and receiver.
- Connect the equipment into an outlet on a circuit different from that to which the receiver is connected.
- Consult the dealer or an experienced radio/TV technician for help.

This device complies with Part 15 of the FCC rules. Operation is subject to the following conditions: (1) This device may not cause harmful interference, and (2) this device must accept any interference received, including interference that may cause undesired operation.

FCC Caution: Any changes or modifications not expressly approved by the party responsible for compliance could void the user's authority to operate this equipment.

Radio Frequency = 2.4GHz.